

# Luxury Doors

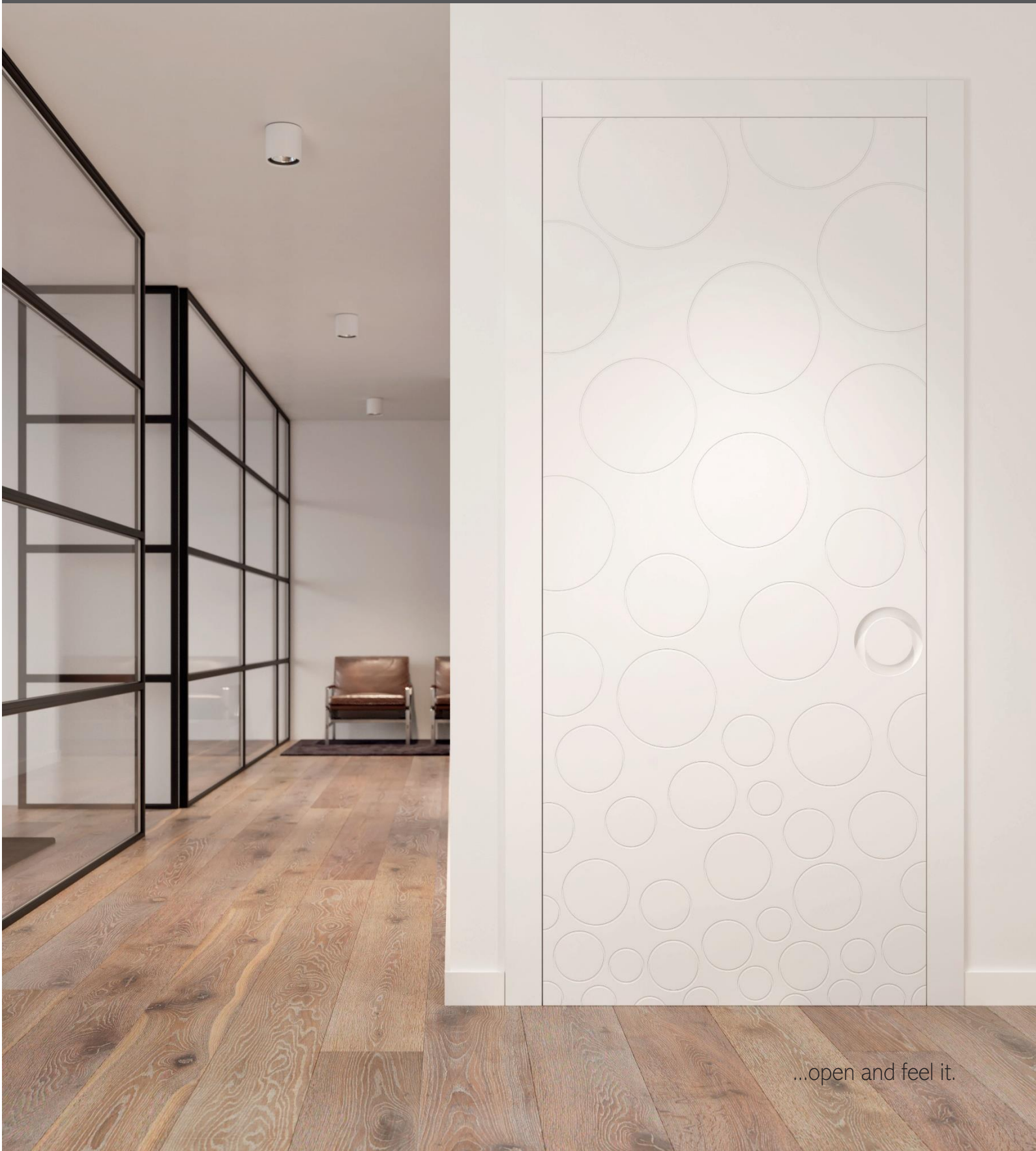

...open and feel it.



## Types de portes \_Doors types

Chacun de ces modèles peut être appliqué à différentes séries de construction, tout comme vous pouvez appliquer et combiner différents matériaux dans le cadre, la garniture et la porte. Les accessoires ne sont pas inclus. Les photographies des portes présentées peuvent ne pas correspondre à la couleur réelle, ainsi que certains aspects techniques dus au processus d'impression du catalogue. Les spécifications et les descriptions présentées peuvent être modifiées sans préavis.

### Laqué \_Lacquered



1F-LAC  
blanc laqué



1FC-1FIA  
frêne/laqué



LF  
blanc laqué élevé brillant /  
bande ébène



2C  
blanc laqué



H2R2  
blanc laqué



1FL-2FIP  
noir laqué



STARS  
noir laqué



1F-LAC  
noir laqué bertura vidro S1

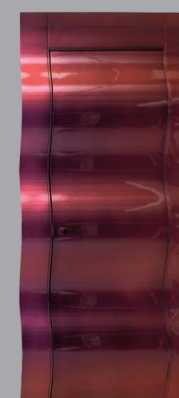

CURV OUT  
multicolor

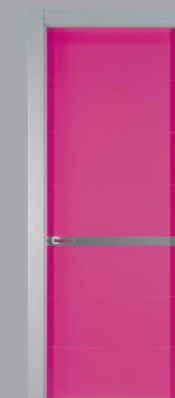

1SS-60  
laqué RAL 4010



1AR  
blanc laqué



2AR  
blanc laqué



4AR  
blanc laqué



2BR  
blanc laqué/  
patine bleu



3BR  
blanc laqué  
c/ patine doré

## Portes avec panneaux latéraux

Doors with sidepanels



INTEGRATED  
blanc laqué



NH  
blanc laqué



WAVES  
bronze laqué

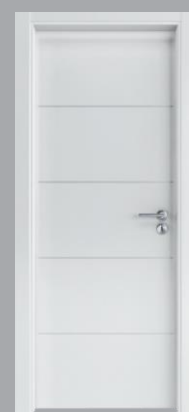

T4FR  
Blanc laqué



T4FR-1FI  
Blanc laqué



T4FRW  
Blanc laqué



T4-FRC  
Blanc laqué



T4-FI  
Blanc laqué



T6-FRH  
blanc laqué



LAM  
frêne blanc laqué



XFR  
blanc laqué alto  
brilho



BOOBLE  
blanc laqué



DIGIPRINTER  
print





Feuilles de Bois - Cuir - Liège\_ Wood Sheets - Leather - Cork



1F  
hêtre vaporisé



1FC  
chêne RW



1FC  
olivier haute brillance



1FC  
palissandre naturel  
haute brillance



3FC  
chêne RW



1F-1FE  
hêtre vaporisé



1F-2FI  
hêtre vaporisé



2FC-1FI  
hêtre vaporisé



2FCA-1FIA  
chêne RW



3FC-2FE  
chêne RW



1FC-4FR  
wenghégris



1FC-4FI  
wenghéRW



FRCS  
noyer naturel



4FE  
noyer naturel



3F-4FE  
ébène RW



6FC-2FI  
ébène RW



1F  
chêne sté



1FPL  
peau



2FCA-PL80  
noyer naturel



WG  
ébène haute brillance



3FC  
ébène RW



CURVIN  
ébène RW



3FC-4SQ  
silverwenghé



2FC/1-PL120  
teka RW



1A-PLB SW  
teka RW



DIGIPRINTER 1FC  
print



16FC  
teka RW



1F  
chêne rustique

Portes avec panneaux latéraux

Doors with side panels



CORKSTRING  
corde de liège

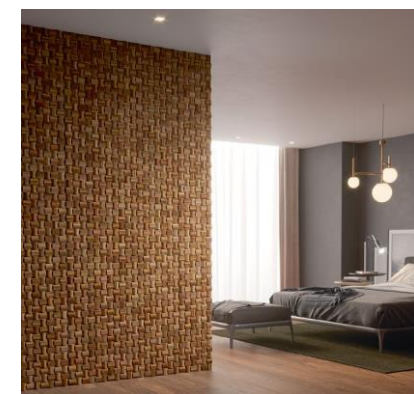

ROTTERDAM  
divers bois  
*\*autres disponibilités sur demande*





CPL\_CPLP

PP



CPL  
blanc



CPL  
gris



CPL  
chêne vertical



\*CPL  
chênedavos



\*CPL  
biscuitnude



PP  
moisissure d'acacia



PP  
pamplona



PP  
ruisseau ashcream



\*PP  
châtaigne



\*PP  
béton



CPL  
frèneglacial



CPL  
noyer



CPL  
wenghè



\*CPL  
crackoak



CPLP-1F  
grain de gris



\*PP  
cooper



\*PP  
tinsand



\*PP  
alaskawhite



\*PP  
chêne de salinas

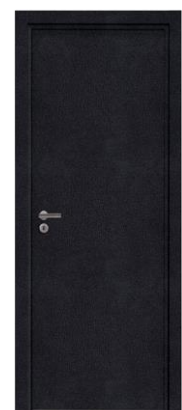

\*PP  
blackleather



CPLP-1F  
chêne blanc



CPLP-1F  
chênenatural



CPLP-1F  
omegrigio



\*CPLP-1F  
fossil



CPLP-4FI  
noirmat



CPLP-3AR-FI  
noirmat



HPL



HPL  
blanc



HPL  
bleu



\*Quantité minimum de 6 unités (par mesure de cadre) ou mesure unique de cadre avec réglage des chambranles, en fonction du stock disponible en usine.  
\* Minimum quantity of 6 units (per rim measure) or single measure with adjustment of the architraves, depending on stock available at the factory.



## Finitions\_ Finisings

### Laqué\_ Lacquered



Laqué blanc White lacquered  
 Laqué choc Chocolate  
 Laqué rose Pink lacquered  
 Laqué rouge Red lacquered  
 Laqué gris Gray lacquered  
 Laqué bronze Bronze lacquered  
 Laqué noir Black lacquered

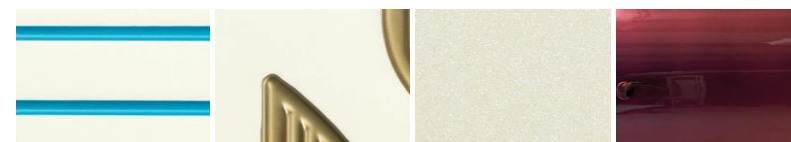

Blanc laqué c/ patine bleu White lacquered with patine blue  
 Blanc laqué c/ patine doré White lacquered with golden patine  
 Laqué pérola miralux Pearl lacquered  
 Laqué multicolor Multicolor lacquered  
 Laqué perle miralux  
 Laqué multicolore

### Feuilles de Bois \_Wood Sheets



Amapa Mayflower  
 Bambu rw Bamboo rw  
 Chêne rwOak rw  
 Chêne naturel Natural oak  
 Cerisier USAUSA cherry  
 Ébène rw Ebony rw  
 Falsa vaporizada Steamed Beech Hêtre



Noyer natural Natural walnut  
 FrêneAsh h  
 Maple Maple  
 Sapei Mahogany  
 Mutene Mutényé  
 Teck rw Teak rw



Wenghe rw Wenghe rw  
 Zebrano rw Zebrano rw  
 Sucupira Sucupira  
 Pin Pine  
 Silver wenghe Silver wenghe  
 Wenghe grisGrey wenghe  
 Olivier Olives

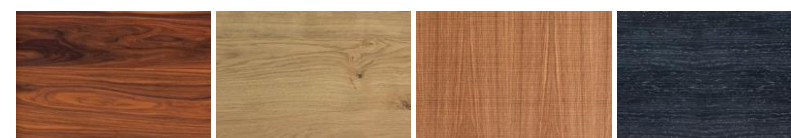

Palissandro naturel Natural Palissandro  
 Chêne RustiqueCrack Oak  
 Chêne scobe Cross cut oak  
 Olmo noir Olmo negro

### Outros Revestimentos \_Other Coatings \_Autres Revêtements



Cuir Leather  
 Liège Cork 1  
 Liège 2 Cork 2

### CPL \_CPL \_CPL



CPL grisCPL grey  
 CPL noyerCPL walnut  
 CPL wengheCPL wenghe  
 CPL frêne glacialCPL glacial ash  
 CPL biscuit nudeCPL biscuit nude  
 CPL blancCPL white  
 CPL crack oakCPL crack oak



CPL chêne verticalCPL vertical oak  
 CPL chêne davosCPLP davos oak

### CPLP \_CPLP \_CPLP



CPLP Noir mat CPLP Black matte  
 CPLP Gris GrainCPLP Gray grain  
 CPLP chêne naturelCPLP natural oak  
 CPLP olmo grigioCPLP olmo grigio  
 CPLP fossil CPLP fossil  
 CPLP chêne blanc CPLP white oak

### PP \_PP \_PP



PP moldau acácia PP moldau acácia  
 PP pamplona PP pamplona  
 PP ribeira ash cream PP ribeira ash cream  
 PP sweet chestnut PP sweet chestnut  
 PP concrete PP concrete  
 PP cooper PP cooper  
 PP tin sand PP tin sand



PP alaska blanc PP alaska withe  
 PP noir leather PP black leather  
 PP salinas oak PP salinas oak

## Serrures et Paumelles \_Locks and Hinges

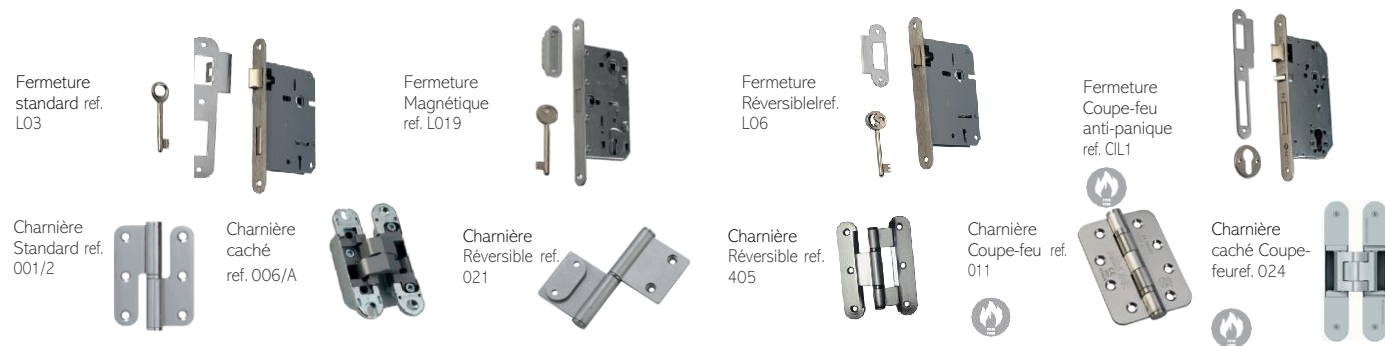

## Accessórios para portas \_Door accessories \_Accessoires de porte

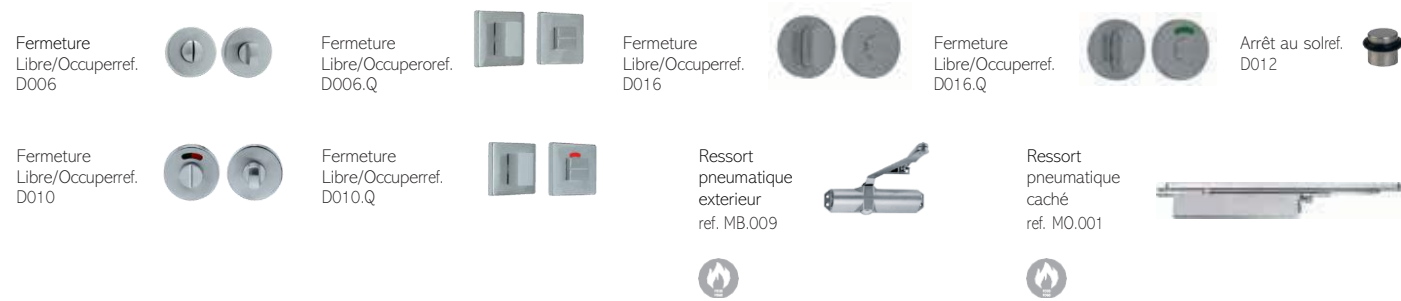

## Serrures et poignées cuvette pour portes coulissantes \_Lock and shells for run doors

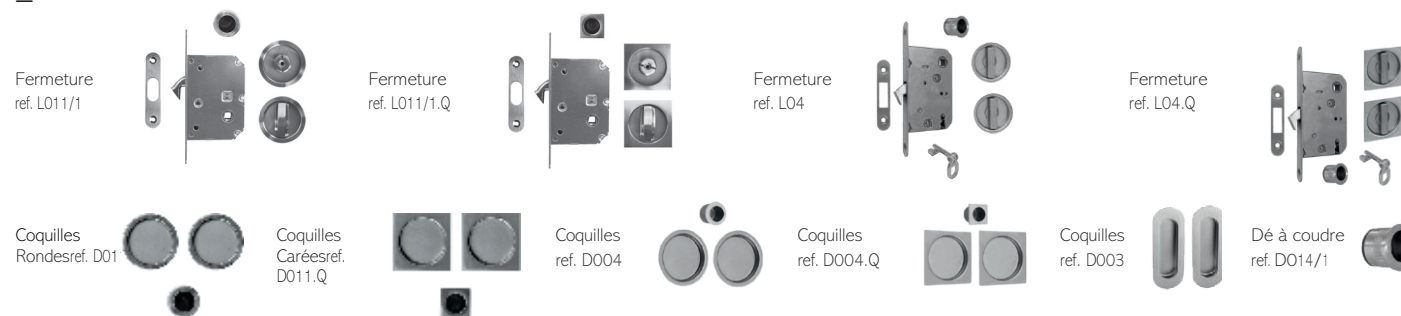

## Poignées \_Handles



Some models are subject to a minimum order quantity. There are several finishes in beyond to the represented (on request).  
 Certains modèles sont soumis à une quantité minimum de commande. Il y a différentes finitions au-delà du représenté (sur demande).

## Montage de la porte standard Kitblock \_Mounting the Kitblock Standard door

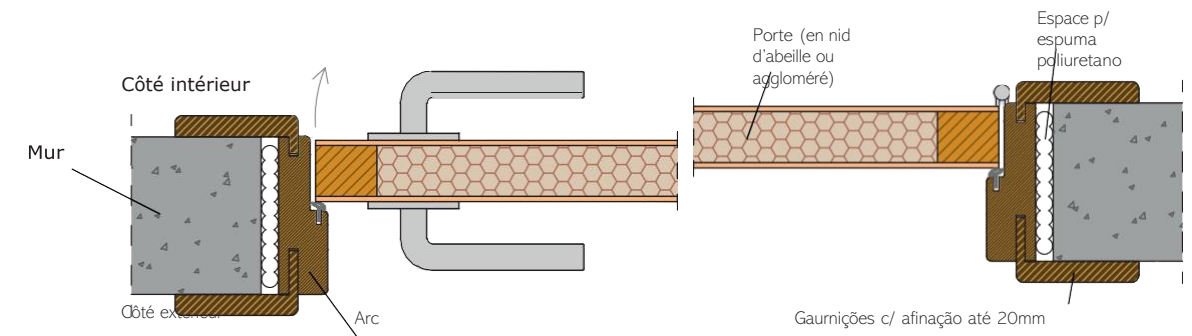

Dans la série Standard quand les cadres sont appliqués avec mousse polyuréthane il se recommande que la dimension en construction est 65mm plus grand que la largeur de la porte prétendue et 40mm plus à hauteur.

- Ei:30 / Ei:45 / Ei:60 - Certifiée coupe-feu EN 1634-1  
 -1 \_Fire certified EN 1634-1 \_
- Portes avec réduction acoustique de 30 à 41 DB'S  
 \_Doors with acoustic reduction of 30 to 41 DB'S \_
- Portes à haute résistance aux chocs/risques  
 \_Doors with high resistance to impact / risk

## Sens d'ouverture \_Opening directions

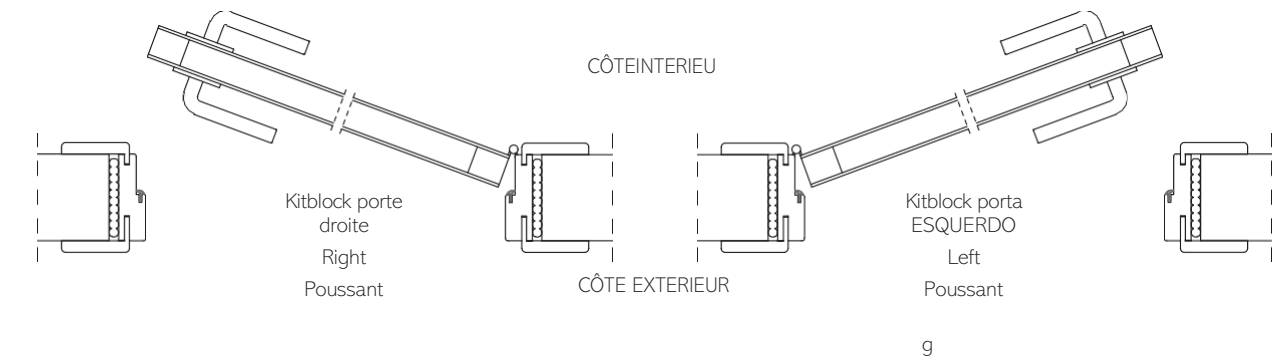

## Cadres et Chambranles \_Frames and Architraves



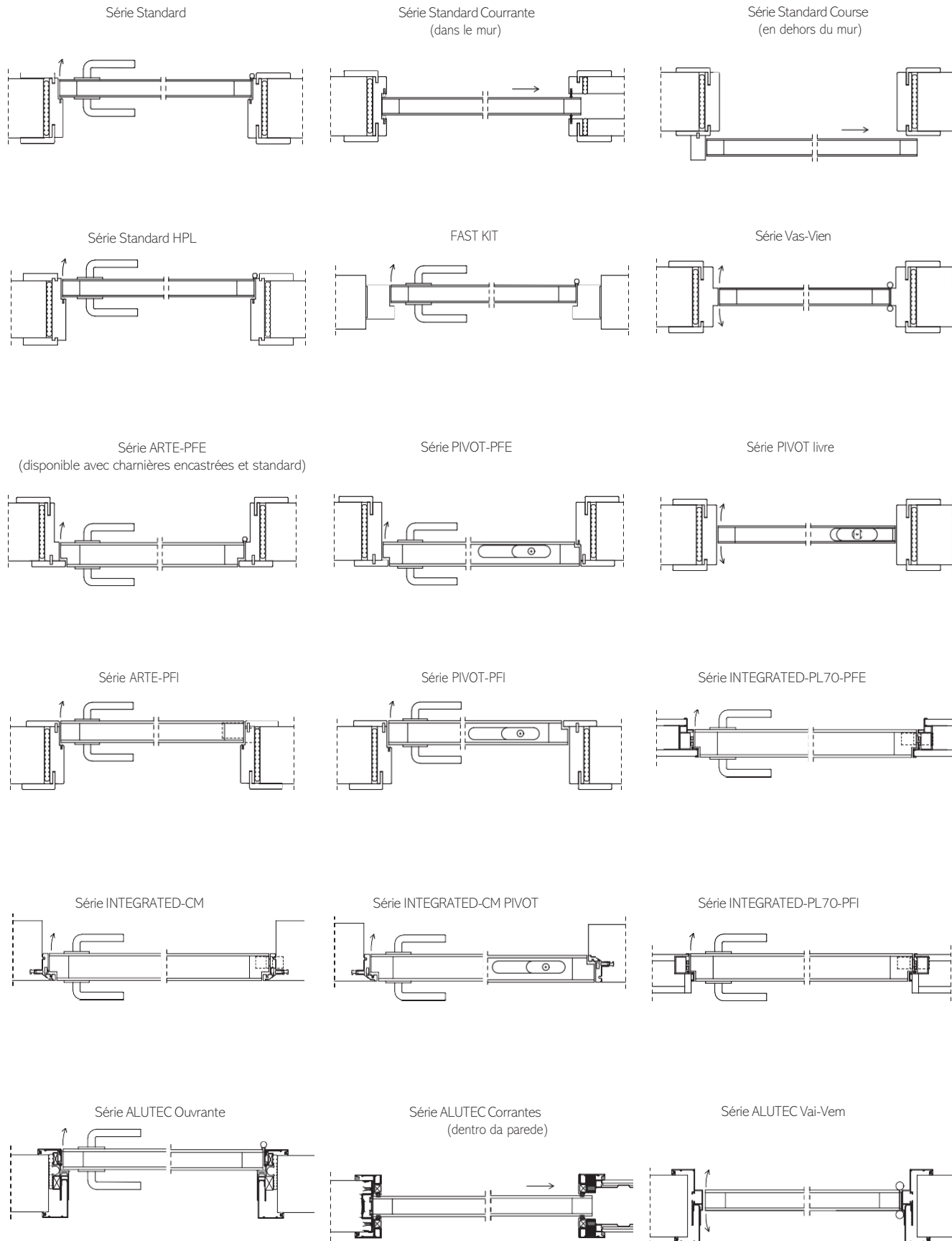

All the construction series shown above have a double equivalent span solution.

Chaque série de construction a ses propres remises à laisser au travail. Sur demande de fiches techniques détaillées. Toutes les séries de construction présentées ci-dessus ont une solution à double portée équivalente.

Série Standard  
Coupe horizontal

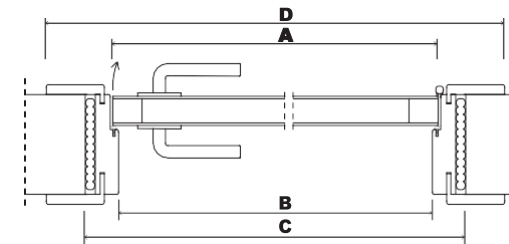

A\_ largeur de porte  
B\_ largeur de passage libre (A - 14mm)  
C\_ largeur de la travée sur site (A + 65mm)  
D\_ largeur d'un bord à l'autre (A + 160mm)  
E\_ hauteur de porte  
F\_ hauteur de passage libre (= E)  
G\_ hauteur de la travée sur site (E + 40mm)  
H\_ hauteur du sol à l'habillage (E + 87mm)  
I\_ hauteur de la travée sur le site (E + 10mm)

Coupe vertical kit  
avec tête

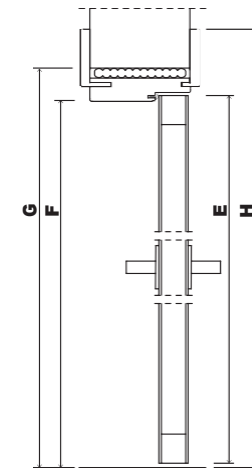

Coupe vertical kit  
sans tête

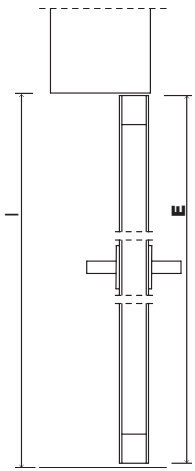

Série Standard Courante  
Coupe horizontal

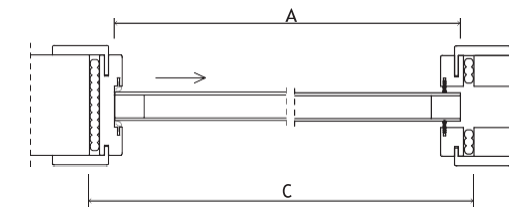

A\_ largeur de porte  
C\_ largeur de la travée sur site (A + 60mm)  
E\_ hauteur de porte  
G\_ hauteur de la travée sur site (E + 35mm)

Coupe vertical kit  
avec tête

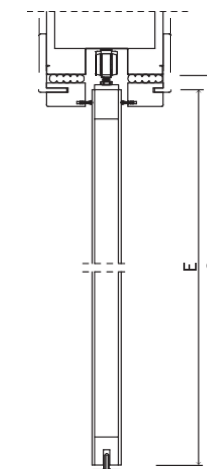

Série ARTE-PFE  
(disponible avec charnières encastrées et standard)  
Coupe horizontal

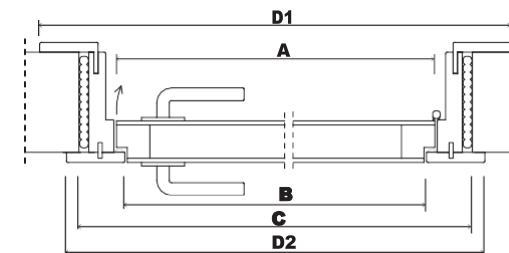

A\_ largeur de porte  
B\_ largeur de passage (A - 20mm)  
C\_ largeur de l'embrasure de la porte sur chantier (A + 85mm)  
D1\_ largeur d'une moulure à l'autre - intérieur (A + 184mm)  
D2\_ largeur d'une moulure à l'autre - extérieur (A + 120mm)  
E\_ hauteur de la porte  
F\_ hauteur du passage libre (E - 3mm)  
G\_ hauteur de la porte (E + 50mm)  
H1\_ hauteur du sol à la garniture - intérieur (E + 99mm)  
H2\_ hauteur du sol à la garniture - extérieur (E + 67mm)  
I\_ hauteur de l'espace dans l'ouvrage (E + 10mm)

Coupe vertical kit  
avec tête

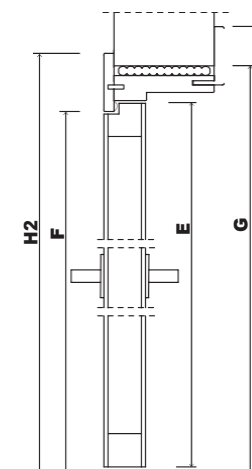

Coupe vertical kit  
avec tête

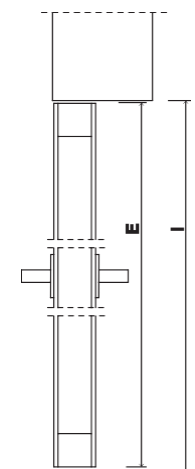

**Jantes disponibles :**  
**100mm et 140mm**  
Pour les autres tailles de mur, l'ajustement se fait à l'aide des garnitures.  
Pour CPL blanc, laqué ou peint par pulvérisation

**Exemple:**  
**cerceau 140mm**  
**pour mur de 140mm et 200 mm**

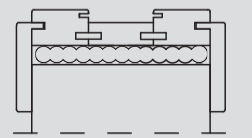

**Mur = 140mm**  
Cerceau 140mm + Raccords (languettes 10mm + 10mm)

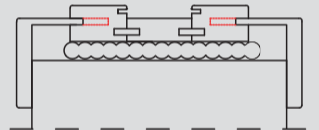

**Mur = 200mm**  
Cerceau 140mm + Raccords (languettes 60mm + 60mm)



## Ouverture pour vitrages\_ Glass opening

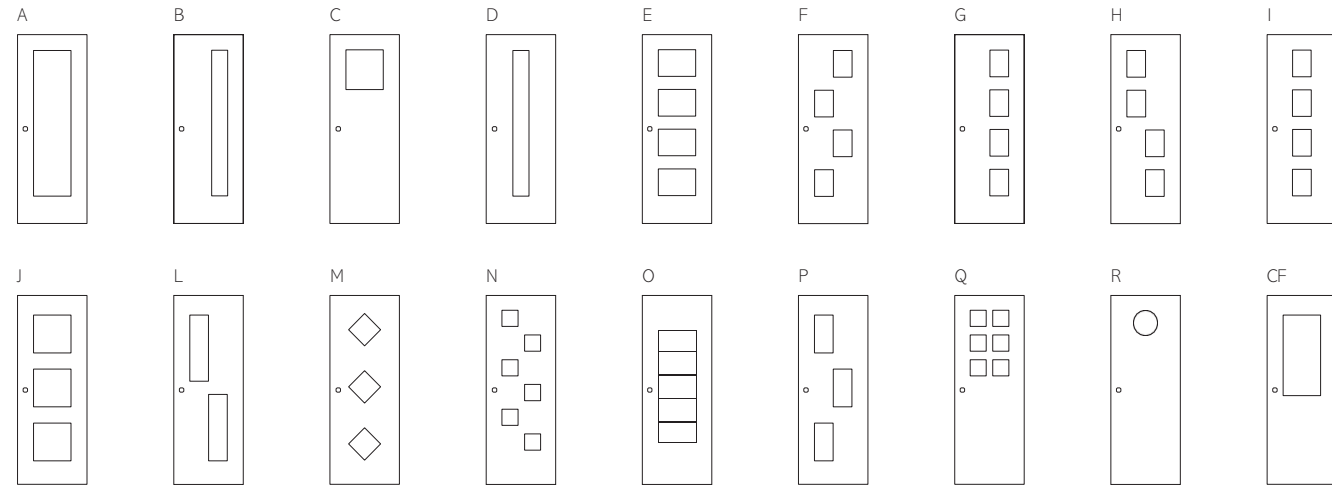

\* Dimensions d'ouverture sur demande, sous réserve de certification incendie

## Applications décoratives\_ Decorative applications

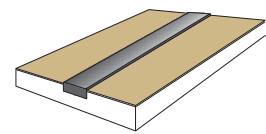

Ref. FI

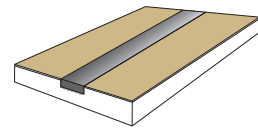

Ref. FIA

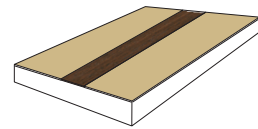

Ref. FE

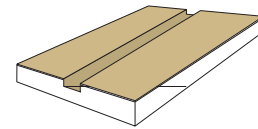

Ref. FR

## Chambranles\_ Architraves

### Chambranles avec réglage Adjusted architraves



Onglet de 10mm



Onglet de 25mm



Onglet de 60mm

## Intérieur de la porte\_ Door interior



Porte alvéolaire  
Honeycomb door



Porte d'aggloméré  
Chipboard door

Models may go out of production without prior notice  
*Les modèles peuvent sortir de la production sans préavis.*

The references of the Presented models are just for the door model, not the full Kit, each model can be applied in different construction systems, and the same way you can apply and combine different materials in the frame, architraves or on the door. The accessories are not included. The Door Photographs may not correspond to the actual color, as well as some technical aspects, due to the process of catalog printing. The specifications and descriptions provided, may change without notice.

*Les références des modèles présentés sont uniquement de la porte, pas le kit Block Porte, chaque modèle peut être appliqué à ces différents systèmes de construction, de la même manière vous pouvez appliquer et de combiner différents matériaux dans le cadre, chambranles et porte. Les accessoires ne sont pas inclus. Les photos des Portes peuvent ne pas correspondre à la couleur réelle, ainsi que certains aspects techniques liés au processus de l'impression du catalogue. Les spécifications et les descriptions fournies peuvent changer sans préavis.*



# Luxury Doors

RGR Multiservices Sàrl

Route de Boudry 22 A

Box 66

[www.rgmultiservices.ch](http://www.rgmultiservices.ch) · E-Mail: [info@rgmultiservices.ch](mailto:info@rgmultiservices.ch)

Tel.: +41 79 406 10 98

Distribuidor Autorizado \_Authorized Dealer \_Revendeur Agréé

